

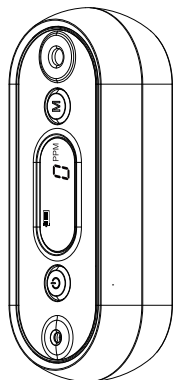

# SA103 Carbon Monoxide Gas Alarm Instruction Manual



## Introduction

SA103 carbon monoxide gas alarm is designed to detect potential toxic carbon monoxide gas in confined spaces. It will alarm wearer to take corresponding protective action by sound, light and vibration once the environmental CO gas concentration exceeds the preset alarm point.

Applications: Indoors, tents, stove heating, vehicles and other confined spaces.

CE RoHS 2.0 REACH IP67

GZAIR provides full after-sales service to any customers. If you have any questions or concerns, please email us via [gzairstervice@outlook.com](mailto:gzairstervice@outlook.com) and we will answer you within 24 hours.

## Overview

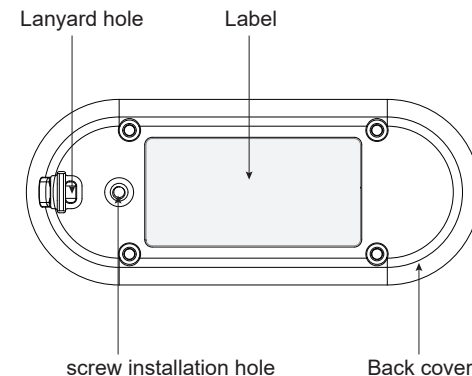
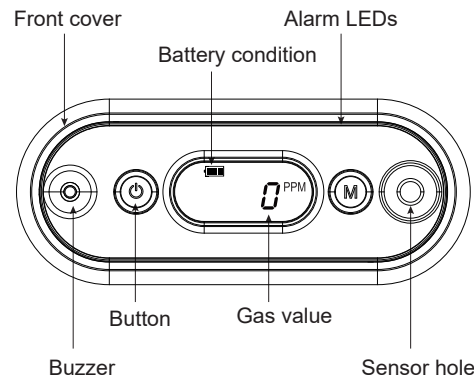

01

## Packing list

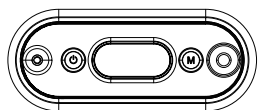

Device x1

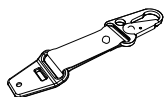

Lanyard x1



Screw x1



Instruction manual x1

## Specification

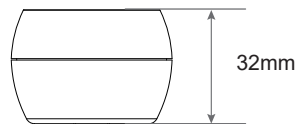
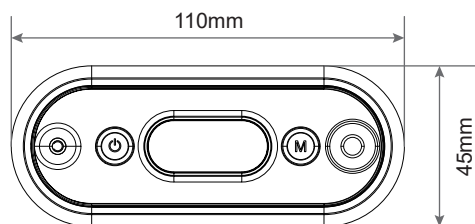

### Appearance

Length: 110mm  
Width: 45mm  
Thickness: 32mm  
Weight: 125g (device only)

05

## User's instruction

**Display:** Real-time show battery condition and CO gas concentration.

**Alarm:** Once CO gas concentration exceeds the preset point, it will alarm by sound, light and vibration.

### Alarm level

CO concentration (ppm)	Alarm
0-49	No alarm: real-time show CO gas concentration.
50-199	Alarm Level I : real-time show CO gas concentration; red light flashes with buzzer sound.
≥200	Alarm Level II : real-time show CO gas concentration; red light flashes with buzzer sound and strong vibration.

02

06

## ON/OFF

To turn on this device, press and hold for 2 seconds. It will display all interfaces in orders, and enter detection mode after a warm-up time of 90 seconds.

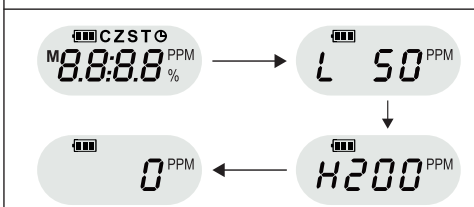

To turn it off, press and hold , until it counts down to 1. Don't release your finger until a black screen is seen.

### ⚠ Attention

**Turn on the device in clear open air, since it will automatically calibrate.**

03

07

04

## Operation

1. Switch interfaces among detection mode, MAX value display and time.

In detection mode, press (M) to toggle among the MAX gas value, time and detection interface.

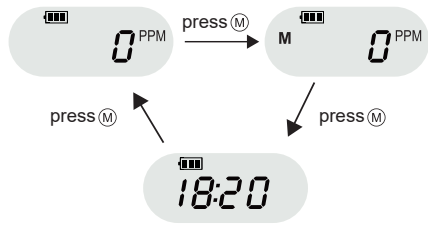

It will return to detection interface after no operation for 6 seconds.

08

## 2. Time setting

In the detection mode, press (M) twice to switch to the time interface, and press and hold (M) for 2 seconds to enter the time setting interface. Press (M) to switch between hour and minute digits, and press (L) to move forward digital number (0-9) by each one step. Press and hold (M) for 2 seconds to complete the setting.

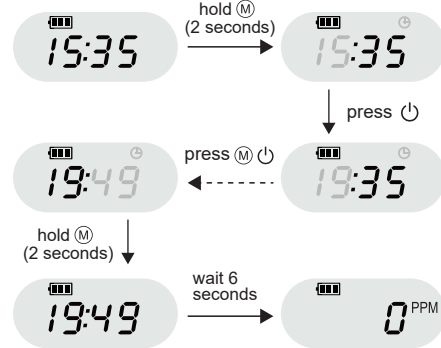

During the processing, it will return to detection interface after no operation for 2 minutes.

09

## Battery replacement

**Low battery display:** Battery icon flashes, and buzzer will sound "Du" every 30 seconds to alarm low battery condition.

**Battery replacement:** Unscrew those 4 mounting screws on the back, remove the back cover, gently take the battery out of the buckle, replace it with a new 9V alkaline battery (Model 6LR61). Buckle it on, and finally screw the back cover.

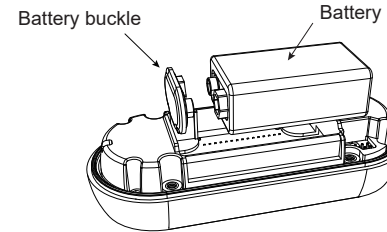

**Attention:** Tighten those 4 screws on the back cover, in case it affects the waterproof performance.

10

## About CO (carbon monoxide)

Concentration of carbon monoxide in the air	Approx. Inhaled time and symptoms may appear
24ppm (30mg/m <sup>3</sup> )	Cause dizzy after 64 hours
50ppm (62.5mg/m <sup>3</sup> )	Cause dizzy after 32 hours
100ppm (125mg/m <sup>3</sup> )	Cause dizzy after 16 hours
200ppm (250mg/m <sup>3</sup> )	After 2-3 hours, slight headache, fatigue, vertigo, nausea
400ppm (500mg/m <sup>3</sup> )	In 1-2hours, headache; after 3hours, threaten life
800ppm (1000mg/m <sup>3</sup> )	Cause vertigo, nausea, cramps within 45 minutes, lost consciousness within 2 hours, death within 2-3 hours

**Attention:** Above poisoning symptoms are based on healthy adults, while for high risk and vulnerable people, pregnant women, the reaction is quite different.

11

## Outstanding CO peak value

This CO gas alarm records peak concentration of CO gas from the moment of Power On to the time when you check the Max value.

Only by pressing the function button can users know if they are in a safe environment or if there is potential carbon monoxide threats.

If it shows a value other than 0ppm, e.g. 200ppm, then users must be alerted for the existence of the carbon monoxide gas.

The delivery of Max value makes it a 24-hour monitor, a nonstop guard for your environmental safety.

12

## Kindly reminder

Detection accuracy of the alarm is influenced by factors like device itself, temperature, humidity of install environment, etc. For installation, recommended proper temperature is 20°C(±5°C); Relative humidity is 50%.

Avoid installing alarms near stoves or heaters. Do not expose the alarm to the sun.

Keep the alarm away from electromagnetic interference which caused by cell phones or other electrical appliances.

Change a new alarm device, after 5 years lifetime.

Turn on the device in clear open air, since it will automatically calibrate.

13

- A. Curvature towards the display area of the device.

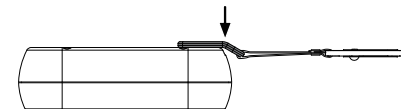

- B. Pay attention to the position of the screw and the lanyard as below and then tighten the provided screw.

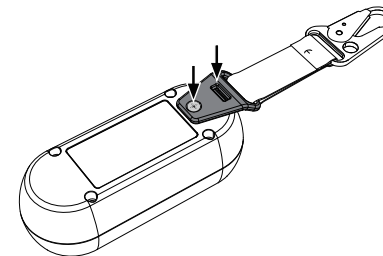

Installation diagram

14



15