

MCH3 user manual

CAN WE HELP?

Your MCH3 Touch Screen Detector comes with a three year warranty from date of purchase. If you have any problems of installing or programming your MCH3 Touch Screen Detector , call our dedicated technical support team, who will be more than happy to help.



WELCOME

The MCH3 Touch Screen Detector makes smart high performance detector easier than ever.

This guide tells you everything you need to know.

Content

Main feature	6
Home screen display	7-8
Outline dimension	9
Configuration settings	10-11
Operation of home screen	12
Power ON/OFF	12
Setup	12
History	13-14
Export the history data.....	15
°C/ °F	16
Lock	16
Set CO2 alert	16
Turn off the alarm speaker.....	17
Feature settings	17
Clock setting	17-18

Temperature format	18-19
Backlight	19
Standby screen	20
Lock	21-22
CO2 set limitation	22-23
Reset CO2 to factory settings.....	23
CO2 Auto Base Line Setting.....	24
CO2 sensor calibration	25
Temperature sensor calibration	26
Humidity sensor calibration	27
Time Zone Selection.....	28
Daylight saving time(DST)	29
Home screen colour.....	30
Alarm Speaker Settings.....	30-31
System information	31
Reset to factory settings	32
Technical data	33-34

Main Feature

- Hardwired , DC5V
- 3.5" TFT color display, 480*320 resolution
- Capacitive touch
- NDIR CO2 sensor
- NDIR life time 15 years
- History data diagram
- With humidity sensor (+/- 3%)
- With ambient light sensor
- CO2 high, low alert message reminder
- C/F temperature display
- Auto change daylight savings (DST)
- Multi language
- Touch screen lockout
- Night light option

Home Screen Display

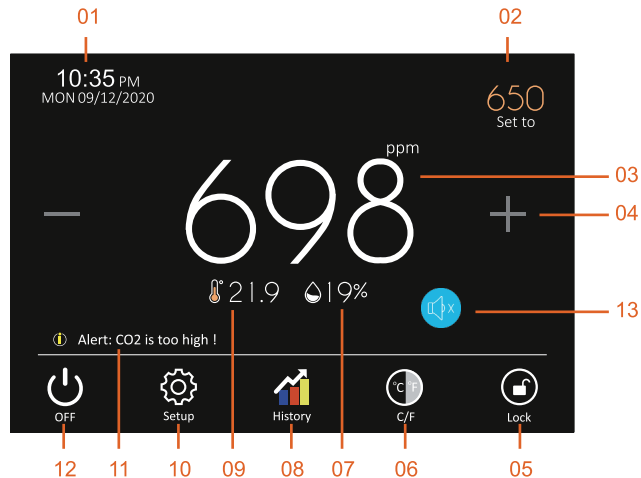

01. Day Indicator & Clock	03. Current CO2 display
02. CO2 setpoint	04. Adjusting the optional settings.
05. Keyboard lockout	06. °C or °F Display
07. Humidity display	08. History data diagram
09. Temperature display	10. Configuration settings
11. Alert message	12. Power On/Off 13. Alarm speaker mute

Outline Dimension

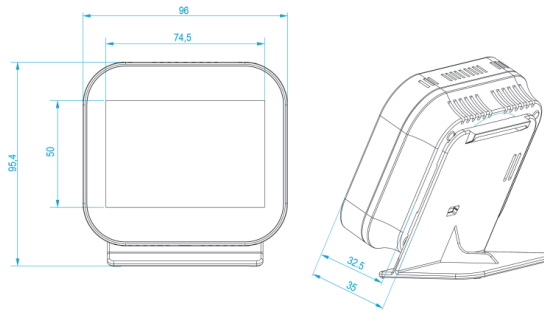



Configuration Settings

Language	English ,Spanish,Italian,Russian, Polish, Czech, German, French, Slovenski, Swedish,Portuguese
Clock settings	Date & Time settings
Temperature Format	°C or °F
Backlight	Set backlight brightness Auto adjust brightness Enable CO2 Control by light sensor
Standby screen	Standby Screen 01) Time: 3min, 10min, Just night 02) Option: black screen or not in standby mode
Lock	4 number PIN Disable/Enable lock
CO2 set limitation	01) Min – 400 ppm 02) Max – 4500 ppm
Reset CO2 to factory settings	Set CO2 sensor to factory settings 400ppm
CO2 Auto Base Line Setting	Enable/Disable ABC function
CO2 sensor calibration	-100 to +100 ppm

Temperature sensor calibration	-5°C to +5°C
Humidity sensor calibration	-30% to + 30%
Time Zone selection	Enable/Disable Time sync (Time sync works only when internet connection is setup) Set the Time zone
Day light saving time	01) Auto DST enable/disable 02) DST selection Europe Union US&Canada Australia & New Zealand
Home Screen Colour	01) Black background home screen 02) Blue background home screen
Alarm Speaker Settings	01) Enable/Disable Alarm 02) High setpoint alarm 03) Low setpoints alarm
Reset to factory	Reset to factory settings
System Information	Version number

Operation Of Home Screen

Power ON/OFF





Press the icon  once to turn on; press the icon  again to turn off.

Setup



Press the icon  and enter Feature Settings.

History



Show the Room CO2(ppm)/Room Temperature(°C)/Room Humidity(%) of the environment in the last 7 Days.

- 01 Press the icon  and enter History Chart.
- 02 There are Three Options: CO2 Chart/Temperature Chart/Humidity Chart.
- 03 CO2 Chart
 - 3.1 Press "CO2 Chart"  to enter Room CO2(ppm) screen, the data will be saved for last 7 days.
 - 3.2 to check each day data, press the Date  to enter Room CO2(ppm) of Each Hour in the day(24 Hours in total).
 - 3.2 Press the icon  to save and return to History Chart display.

04 Temperature Chart

- 4.1 Press "Temperature Chart"  to enter Room Temperature(°C) , the data will be saved for last 7 days.
- 4.2 Press the Date  to enter Room Temperature(°C) of Each Hour in the day(24 Hours in total).
- 4.3 Press the icon  to save and return to History Chart display.

05 Humidity Chart

- 5.1 Press "Humidity Chart"  to enter Room Humidity (%) screen, the data will be saved for last 7 days.
- 5.2 Press the Date  to enter Room Humidity (%) of Each Hour in the day (24 Hours in total).
- 5.3 Press the icon  to save and return to main display.



Export the history data

MCH3 could save 7 days history data, it records data once an hour, you can export the data to PC, below is the operation steps:

- 01 In the home screen press the icon  enter History Chart.
- 02 Press the button of "Save to file" on the bottom of screen.
- 03 Connect the USB cable to PC USB port , then see a U-disk on the PC.
- 04 Go to the U-disk , find a txt file named DATALOG.TXT, and copy it to wherever you need. There are all history data till you press the button " Save to file" , included data, time, CO2 , temperature, humidity .



°C / °F

Switch current temperature from °C  to °F .



Lock

Please refer to the Lock  instructions in Setup .



Set CO2 Alert

There are two set points, Low and High, user could set two alerts : low and high set point, when the CO2 lower than Low setting, the CO2 font will be GREEN color; when the CO2 higher than High setting, the CO2 font will be RED color ; When the CO2 is lower than High set point and higher than Low set point, the CO2 font will becomes Yellow color.



Turn off the alarm speaker

When the room CO2 is higher than the alarm set point, the speaker will be turned on, you can turn off the speaker temporarily by press the “Mute” icon on home screen.

If you want to turn off the speaker, please go to the feature settings menu “beep alarm” to Disable the alarm speaker.



Feature Settings



Clock Setting

To set the clock, follow these steps.



- 01 Press the icon  and enter Feature Settings.
- 02 Press the “Clock Setting” and enter Setting screen.

- 03 Press the column of Month/Day/ Year, use the icon  to set the Month,Day, Year .
- 04 Press the column of “Time” , use the icon  to set Hours/ Minute.
- 05 Press the icon  to save and return to main display.



Temperature Format

Switch temperature format between °C and °F.





- 01 Press the icon  and enter Feature Settings.
- 02 Find the “Temp Format” option, press it and enter setting screen.
- 03 There are two Options °C / °F .
- 04 Press the icon  in the front of °C or °F , and it will turn to  .

- 05 Press the icon  to save and return to main screen.



Backlight





To adjust the backlight brightness, follow these steps.

- 01 Press the icon  and enter Feature Settings.
- 02 Press “Backlight” Selection and enter Backlight Setting.
- 03 Ambient Light Dimming is in  Mode: Automatically adjusts the backlight brightness.
- 04 Ambient Light Dimming is in  Mode: Manually adjust the backlight brightness.
- 05 Use the icon  to adjust to the desired brightness.
- 06 Press the icon  to save and return to main display.



Standby Screen







The standby screen activates whenever the MCH3 is not in use for some time.

- 01 Press the icon  and enter Feature Settings.
- 02 Press "Standby Screen" and enter Setting screen.
After Standby, black screen?  Options
- 03 There are Four Selection (3Min, 10Min, Just Night, Never) to control the Standby Screen Time.
- 04 For example, setting the standby time is for 10 minutes.
Press the icon  in the front of "10 Min" and it will turn to .
- 05 Press the icon  to save and return to main screen.



Lock

The MCH3 has a keypad lock facility. To activate the lock, follow these steps.

- 01 Press the icon  and enter Feature Settings.
- 02 Press "Lock" and enter setting screen.
- 03 Lock Pin is in  Mode:
- 04 For example, Setting the Lock Pin is 5209
Press the First Column, use the icon  to set to 5
Press the Second Column, use the icon  to set to 2
Press the Third Column, use the icon  to set to 0
Press the Fourth Column, use the  to set to 9
- 05 Press the icon  to save and return to main screen.

Note: To unlock the MCH3 press. The display will show Lock Pin screen and you need to enter the four digit PIN number you set previously to unlock it.

Master PIN is 8657

06 Lock Pin is in  Mode:

07 Press the icon to return to main screen.

PLEASE NOTE: if the LOCK feature is not enabled, the  mode in home screen can't be modified.





CO2 Set Limitation

To set the the Minimum CO2 PPM or the Maximum CO2 PPM, follow these steps.

01 Press the icon  and enter Feature Settings.

02 Find the “CO2 Set Limitation” option, press it and entry in setting screen.

03 Press the First Column, use the icon  to set the Minimum CO2 PPM.

04 Press the Second Column, use the icon  to set the Maximum CO2 PPM.

05 Press the icon  to save and return to main screen.



Reset CO2 to factory settings

To reset the CO2 sensor to factory setting, please take the detector to outside of room and run for 10mins, then follow these steps.

01 Press the icon  and enter Feature Settings.

02 Find the “Reset CO2 to factory settings” option, press it and entry in setting screen.



03 Press the button “Start” , wait till the counting down time is finished.

04 Press the icon  to save and return to main screen.



CO2 Auto Base Line Setting



To reset the CO2 Auto base line please follow these steps.

- 01 Press the icon  and enter Feature Settings.
- 02 Find the “CO2 Auto Base Line Setting” option, press it and entry in setting screen.
- 03 Press the button Disable/Enable to turn Off/On ABC function.
- 04 Press the icon  to save and return to main screen.





CO2 Sensor Calibration

If you need to calibrate the CO2, follow these steps.

- 01 Press the icon  and enter Feature Settings.
- 02 Find the “CO2 Sensor Calibration” option, press it and entry in setting screen.
- 03 Use the icon  to adjust to the desired calibration.
- 04 Press the icon  to save and return to main screen.

NTC Temperature Sensor Calibration



If you need to calibrate the temperature, follow these steps.

- 01 Press the icon  and enter Feature Settings.
- 02 Find the “Temperature Sensor Calibration” option, press it and entry in setting screen.
- 03 Use the icon  to adjust to the desired calibration.
- 04 Press the icon  to save and return to main screen.







Humidity Sensor Calibration

If you need to calibrate the humidity, follow these steps.

- 01 Press the icon  and enter Feature Settings.
- 02 Find the “Humidity Sensor Calibration” option, press it and entry in setting screen.
- 03 Use the icon  to adjust to the desired calibration.
- 04 Press the icon  to save and return to main screen.





Time Zone Selection

To modify the Time zone, please follow these steps.

- 01 Press the icon  and enter Feature Settings.
- 02 Find the "Time Zone Selection" option, press it and entry setting screen.
- 03 Use the icon  to adjust to the desired time zone.
- 04 Press the button  to turn On/Off Time sync with internet time, this needs detector connects to internet successfully.
- 05 Press the icon  to save and return to main screen.

Daylight Saving Time(DST)



If you need to enable the DST function, follow these steps.

- 01 Press the icon  and enter Feature Settings.
- 02 Press "DST" and enter setting screen.
Auto DST  Options.
- 03 There are three options:
European Union/US & Canada/Australia & New Zealand
- 04 Press the icon  in the front of "EU / U&C / A&Z" and it will turn to .
- 05 Press the icon  twice to save and return to main screen.



Home screen colour

To change the home screen background colour , follow these steps.

- 01 Press the icon  and enter Feature Settings.
- 02 Find the “ Home screen colour” option, press it and entry setting screen.
- 03 Select the desired home screen colour , blue or black.
- 04 Press the icon  to save and return to main screen.



Alarm Speaker Settings

To modify alarm speaker settings, follow these steps.

- 01 Press the icon  and enter Feature Settings.

02

Find the “Alarm Speaker Settings” option, press it and entry setting screen.

03

Select the  button to Enable/Disable the speake

04

Alert High settings: when CO2 value is higher than high setpoint the speaker will be worked.
Alert Low settings: when CO2 value is higher than Low setpoint the speaker will be worked.



05

Press the icon  to save and return to main screen.



System Information



To know the system information, follow these steps.

- 01 Press the icon  and enter Feature Settings.
- 02 Press “System Information” and enter screen, it shows Version Number.
- 03 Press the icon  to Exit.



Reset to Factory Settings

The MCH3 has a reset function to restore all settings to their factory defaults.

- 01 Press the icon  and enter Feature Settings.
- 02 Press  and enter setting screen.
- 03 Press "Reset" to factory settings.
- 04 Press the icon  to Exit.

Warning: Reset will make you lose the current Settings and return to the factory Settings.

Technical Data

Supply voltage	USB power supply, DC5V;
Display	320x480 pixels color TFT screen- capacitive touch panel
Operating temperature	1°C- 85°C
CO2 sensor type	Dual NDIR
CO2 accuracy	@22°C(72°F)±40ppm + Display*2%
CO2 detective range	0-5000 ppm
NDIR life time	15 Years
Displayed temperature resolution	0.1°C
Displayed CO2 resolution	1 ppm
Standby consumption	≤0.5 W

Display dimensions	76.5 X 52 mm(W/H)
Dimensions (W/H/D)	96 * 86 * 32.5 (mm)
Weight	≤200 g
Enclosure rating	IP 21
Product material	PC + ABS plastic

Notes
